**FPU® SYSTEMS OPERATION MANUAL
(INCLUDING REPAIR PARTS & SPECIAL TOOL LIST)
BOH CONTAINERIZED MISSION SYSTEMS
CCC and EWCC
BOH FPU Field Pack-up Units**



Containerized Command Center (CCC)



Expandable Wall Command Center (EWCC)

**BOH ENVIRONMENTAL LLC
14520 Avion Parkway, Suite 220
Chantilly, Va. 20151
POC Doug Cresap (985) 674-0725
<http://www.bohfpusystems.com>**

This page was intentionally left blank

WARNING SUMMARY

This warning summary contains general safety warnings and hazardous materials warnings that must be understood and applied during operation and maintenance of this equipment. Failure to observe these precautions could result in serious injury or death to persons using equipment.



WARNING

Do not allow the system to swing if using an overhead lift. Always ensure an appropriate sling is used in the lift. Always use properly sized forklift, crane, or lifting device. Failure to comply could cause injury, death or damage to the equipment.



WARNING

The EWCC and CCC containers are **not ISO-certified or CSC Safety-Approved**. When transporting or storing, never stack the containers. The structure is not designed to support additional containers. Failure to comply could cause damage to the container and equipment or death or injury.



WARNING

Use extreme caution when loading or unloading the Containerized Mission System container to or from a transport vehicle. Keep hands, fingers, and feet clear of the container and components during this operation. Forklift support is required. Make sure all container connectors are properly seated and locked secure. Failure to comply could cause serious injury. Failure to follow proper connection procedures may result in injury, death, or damage to the equipment.



Standard forklift principles apply when working with or on the Containerized Mission System container. Ground guides and the MHE operators must insure that personnel are clear of the containers during this operation. When working with ground guides during the loading or unloading, never move the container while the ground guide is unseen. Serious injury could occur if the ground guide is pinned between the Containerized Mission System container and other objects. Forklift operators must maintain visual contact with their ground guides at all time.



Always follow standard forklift procedures. A tilt hazard exists when forklift operators try to lift a Containerized Mission System container from the wrong end. Always lift a container via the forklift pockets that are provided. Ensure the forklift tines are seated deep enough. A tilt situation exists when the heaviest part of the load is out on the tips of the tines. Danger exists when moving on uneven ground, with forks fully extended while traveling. Operators should always keep loads low and close to the forklift carriage. Operators should never travel when the load is in an extended position.



Fall hazards exist when climbing onto or working from the top of the container. Always maintain three points of contact when climbing onto the CCC and EWCC container. Never move, step, or walk backwards when working on top. All movement should be in the forward direction. A fall can occur if personnel loses concentration and steps backwards off the edge. Stand erect only if necessary and only away from the edge. Working from a kneeling position helps reduce the threat of a fall.

The CCC and EWCC interior floor and rooftop will encounter mud, snow, ice, rainwater, and other potentially slippery substances. Keeping the inside floor of the containers clean is important; nevertheless, when these conditions exist, always move with caution inside CCC and EWCC containers. Failure to maintain cleanliness could cause a slip and injury.

WARNING SUMMARY

This warning summary contains general safety warnings and hazardous materials warnings that must be understood and applied during operation and maintenance of this equipment. Failure to observe these precautions could result in serious injury or death to persons using equipment.

WARNING



The Containerized Mission System and their contents are heavy and could cause injury if they fall onto or strike personnel. A tilt hazard exists when the Containerized Mission System is being loaded to or from a transport vehicle when drawers and internal materials are not locked down. Always ensure that all material is secured prior to lifting or loading the Containerized Mission System. Ensure hands, feet and limbs are clear of the container and components during any forklift or lifting operation.

WARNING



The Containerized Mission System accessories can be heavy and awkward to handle by a single person. Seek assistance when lifting or moving heavy components. This is especially true of the larger components like the HVAC unit, cabinets and EWCC EXPANDO units.

WARNING



Storing or transporting flammable materials in the Containerized Mission System is not recommended. Storing or transporting these materials in the container may create a fire safety, explosive or toxic vapor hazard.



Fluorescent tubes contain hazardous material. For proper disposal of fluorescent tubes, refer to DOD 4160.21-M page 10.1-12.

WARNING SUMMARY

This warning summary contains general safety warnings and hazardous materials warnings that must be understood and applied during operation and maintenance of this equipment. Failure to observe these precautions could result in serious injury or death to persons using equipment.

Container Overhead Power Line Warning



WARNING

Overhead power lines and obstructions can cause serious injury or damage to property. Forklift operators, truck drivers, and ground guides should always clear overhead when loading, unloading, moving the Containerized Mission System or when accessing the roof.



WARNING

To prevent electrical shock hazard, only trained and qualified personnel should attempt to correct electrical discrepancies. Additionally, electrical power must be disconnected before any electrical system work is performed.



WARNING

Protective gloves should be worn when handling metal parts in high temperatures. Failure to wear gloves may result in burning or blistering of the skin upon contact.

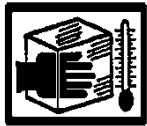

WARNING

Protective gloves should be worn when handling metal parts in below freezing temperatures. Failure to wear gloves may result in skin freezing to the metal upon contact and cause tearing of the flesh when attempting to pull away from the metal.

WARNING



The Containerized Mission System is NOT designed to be operated in contaminated NBC Environments.

The Containerized Mission System is designed to operate outside an established NBC safety perimeter.

Do not operate the Containerized Mission System in contaminated NBC environments. If possible, cease operation of the Containerized Mission System prior to an NBC event and do the following:

1. Close and secure all doors. External surfaces of the Containerized Mission System are CARC painted and can be decontaminated, however, whenever possible avoid contamination of the internal areas of the CONTAINERIZED MISSION SYSTEM.
2. Decontaminate the exterior surfaces of the Containerized Mission System in accordance with FM 3-5. Only Qualified NBC NCO's should check for residual contamination before opening the container.
3. Remain in MOPP 4 posture when opening the doors and have the NBC NCO check for contamination on interior surfaces.
4. If thorough, decontamination is required refer to NBC NCO and FM 3-5 for procedures.

GENERAL WARNINGS



HEAVY PARTS - heavy object on human figure shows that heavy parts present a danger to life or limb.



HEAVY PARTS - heavy object pinning human figure against wall shows that heavy, moving parts present a danger to life or limb.



HEAVY PARTS - hand with heavy object on top shows that heavy parts can crush and harm.



HEAVY PARTS - foot with heavy object on top shows that heavy parts can crush and harm.



SLICK FLOOR - wavy line on floor with legs prone shows that slick floor presents a danger for slipping or falling.



HEAVY OBJECT - human figure stooping over heavy object shows physical injury potential from improper lifting technique.



ELECTRICAL - electrical wire to arm with electricity symbol running through human body shows that shock hazard is present.

GENERAL WARNINGS



ELECTRICAL - electrical wire to hand with electricity symbol running through hand shows that shock hazard is present.



CRYOGENIC - hand in block of ice shows that the material is extremely cold and can injure human skin or tissue.



FIRE - flame shows that a material may ignite and cause burns.



VAPOR - human figure in a cloud shows that material vapors present a danger to life or health.



EYE PROTECTION - person with goggles shows that the material will injure the eyes.



EXPLOSIVE GASSES PRECAUTIONS- Gasses from batteries and other material may be stored in the containers or modules. Special precautions should be taken.

This page was intentionally left blank

**FPU® SYSTEMS OPERATION MANUAL
 (INCLUDING REPAIR PARTS & SPECIAL TOOL LIST)
 BOH CONTAINERIZED MISSION SYSTEMS
 CCC and EWCC
 BOH FPU Field Pack-up Units
 MANUAL TABLE OF CONTENTS**

REPORTING ERRORS AND RECOMMENDING IMPROVEMENTS

You can help improve this manual. Please let us know if you find any mistakes or if you know of a way to improve the procedures. You may send in your recommended changes by E-mail directly to: dcresap@bohfpusystems.com. A reply will be furnished directly to you.

Approved for public release; distribution is unlimited.

TABLE OF CONTENTS

	<u>WP Sequence No.</u>
WARNING SUMMARY	a
TABLE OF CONTENTS	i
HOW TO USE THIS MANUAL	iii
CHAPTER 1 – INTRODUCTORY INFORMATION WITH THEORY OF OPERATION	
General Information	0001 00
CCC Theory of Operation	0002 00
EWCC Theory of Operation	0003 00
Mission System Orientation	0004 00
Mission System Characteristics, Components and Accessories	0005 00
Equipment Data Labels, Identifications, Markings	0006 00
CHAPTER 2 – OPERATOR INSTRUCTIONS	
Movement and Transport	0007 00
Door Operation	0008 00
CCC Electrical System	0009 00
EWCC EXPANDO Operation	0010 00
EWCC Electrical System	0011 00
Operation Under Unusual Conditions	0012 00
CHAPTER 3 - TROUBLESHOOTING PROCEDURES	
Introduction	0013 00
Troubleshooting Indexes	0014 00
Troubleshooting Procedures Table 1	0015 00
CHAPTER 4 – OPERATOR MAINTENANCE INSTRUCTIONS	
Introduction to Preventative Maintenance Checks and Services (PMCS)	0016 00
PMCS Table	0017 00
Cleaning and Lubricating Tables	0018 00
EWCC Exterior Inspection	0019 00
CCC Exterior Inspection	0020 00

EWCC Interior Inspection	0021 00
CCC Interior Inspection	0022 00
CCC/EWCC Electrical System Inspection	0023 00

CHAPTER 5 – UNIT MAINTENANCE INSTRUCTIONS

Rivet Replacement	0024 00
EWCC Exterior Inspection	0025 00
CCC Exterior Inspection	0026 00
EWCC Interior Inspection	0027 00
CCC Interior Inspection	0028 00
CCC/EWCC Electrical System Inspection	0029 00

CHAPTER 6 – PARTS SUPPORTING INFORMATION

Introduction to Maintenance Allocation Chart (MAC)	0030 00
Maintenance Allocation Chart (MAC).....	0031 00
EWCC Exterior Repair Parts	0032 00
EWCC Interior Repair Parts.....	0033 00
CCC Exterior Repair Parts	0034 00
CCC Interior Repair Parts.....	0035 00

00	EWCC / CCC SYSTEMS
01	EWCC EXTERIOR
0101	EXPANDO A Side
0102	EXPANDO B Side
010201	HVAC Cover
0103	EXPANDO Exterior Seals
0104	Door Assembly
02	EWCC INTERIOR
0201	EXPANDO A Side
020101	Overhead Cabinets
020102	EXPANDO A Parts
0202	Lights
0203	EXPANDO Desk Chairs
0204	EXPANDO Desk
0205	Upper Shelf
0206	EXPANDO B Side
020601	HVAC Assembly
020602	HVAC Retrofit Kit
020603	HVAC Thermostat Kit
020604	EXPANDO B Parts
0207	Ceiling / Floor EXPANDO Parts
0208	End Wall
03	CCC EXTERIOR
0301	CCC Exterior Parts
030101	HVAC Cover
030102	Door Assembly
04	CCC INTERIOR
0401	HVAC Side
040101	Overhead Cabinets
040102	Desk
040103	Desk Parts
040104	Upper Shelf
040105	File Cabinets
040106	HVAC Assembly
04010601	HVAC Retrofit Kit
04010602	HVAC Thermostat Retrofit Kit
0402	COMM Side
0403	End Wall
0404	Lights

NSN Index.....	0036 00
Part Number Index	0037 00

REAR MATTER

BOH product Warranty
Metric Conversion Chart

Appendices

Appendix A - LG HVAC User Manual
Appendix B – Expando Seal Replacement Procedures

HOW TO USE THIS MANUAL

This manual contains general information, operating instructions, Preventative Maintenance Checks and Services (PMCS), and maintenance/repair instructions for the Office Module.

Front matter consists of front cover, warning summary, title block, table of contents, "how to use this manual" pages, and provides information on the Containerized Mission System and its associated equipment. Chapter 1 provides equipment description and data as well as basic the theory of operation for the Containerized Mission Systems. Chapter 2 provides instructions for operating under usual and unusual conditions. Chapter 3 contains troubleshooting procedures authorized at the Operator and Unit level. Chapter 4 contains Preventative Maintenance Checks and Services (PMCS) and Operator Maintenance Instructions. Chapter 5 contains Unit Maintenance Instructions. Chapter 6 contains the Maintenance Allocation Chart (MAC); it also includes the Repair Parts & Special Tools List (RPSTL) that identifies parts or tools unique to the operation and maintenance of the Containerized Mission System and components.

Manual Organization and Page Numbering

This manual is divided into six major chapters that detail the topics mentioned above. Within each chapter are work packages covering a wide range of topics. Each work package is numbered sequentially at page 1, and has its own page numbering scheme that is independent of the page numbering used by other work packages. Each page of a work package has a page number of the form "XXXX YY-ZZ", where "XXXX YY" is the work package number (e.g. 0010 00 is work package 10) and "ZZ" represents the number of the page within that work package. Blank pages will be labeled; "This page was intentionally left blank".

Finding Information

The Table of Contents permits the reader to quickly find information in the manual. The reader should start here first when looking for a specific topic. The Table of Contents lists the topics contained within each chapter and the work package sequence number where it can be found.

Types of Notations

Warnings - Warnings are posted immediately prior to text covering any area that would present a situation that may result in injury or death. Compliance is mandatory.

Cautions - Cautions will be found on the same page and preceding the text covering any area that would present a situation that may result in damage to equipment.

Notes - Notes will precede text covering an area with the intent to alter normal procedures for unique situations or equipment, or point out areas of special concern.

This page was intentionally left blank

**FPU® SYSTEMS OPERATION MANUAL
(INCLUDING REPAIR PARTS & SPECIAL TOOL LIST)
BOH CONTAINERIZED MISSION SYSTEMS
CCC and EWCC
BOH FPU Field Pack-up Units**

CHAPTER 1

**INTRODUCTORY INFORMATION
WITH
THEORY OF OPERATION**

This page was intentionally left blank

INTRODUCTORY INFORMATION WITH THEORY OF OPERATION

**FPU® SYSTEMS OPERATION MANUAL
(INCLUDING REPAIR PARTS & SPECIAL TOOL LIST)
BOH CONTAINERIZED MISSION SYSTEMS
CCC and EWCC
BOH FPU Field Pack-up Units**

GENERAL INFORMATION

SCOPE**Equipment Covered**

This technical manual contains instructions for the operation, preventative maintenance, and recommended Unit/Direct Support corrective maintenance for the Containerized Mission Systems (CMS) and the associated equipment of the Containerized Command Center (CCC) and Expandable Wall Command Center (EWCC).

Type of Manual

This is an Operator, Unit and Direct Support, Operation and Maintenance Manual.

Equipment Name, Part Number and NSN

BOH Containerized Mission System Table

Containerized Mission System	PART NUMBER	NSN
Containerized Command Center (CCC) Green	CCC208-001	8145-01-502-3930
Containerized Command Center (CCC) Tan	CCC208-002	8145-01-502-3930
Expandable Wall Command Center (EWCC) Green	EWCC208-001	8145-01-502-3927
Expandable Wall Command Center (EWCC) Tan	EWCC208-002	8145-01-502-3927
End of BOH Containerized Mission System Table		

Containerized Mission System (CMS) Types

The Containerized Mission System (CMS) consists of a range of mission specific support containers. The CMS come in two color variations: Green and Tan.

Containerized Command Center (CCC) Is a highly transportable, all-steel container that measures 8' W x 8' H x 20' L and is designed for use as a self-contained disaster response, expeditionary command or logistics support facility, supporting four computer stations with HVAC and forklift pockets for movement to a desired location.

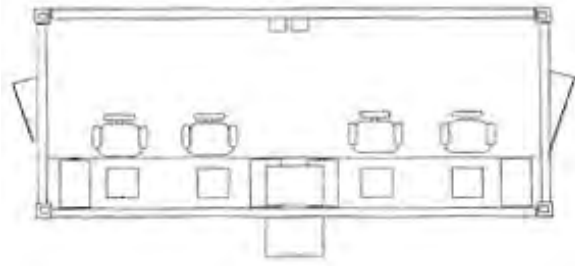

Expandable Wall Command Center (EWCC) Is a highly transportable, all-steel container that measures 8' W x 8' H x 20' L and is designed for use as a self-contained disaster response, expeditionary command or logistics support facility, with expandable walls that extend beyond the transport envelope supporting six computer stations with HVAC and forklift pockets for movement to a desired location.

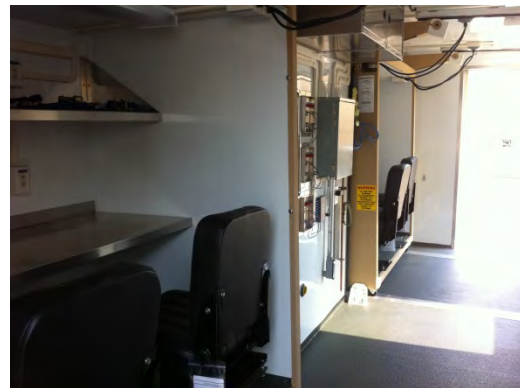
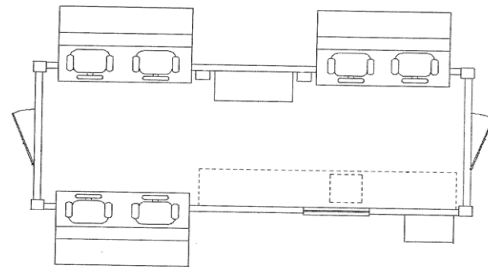

END OF WORK PACKAGE

INTRODUCTORY INFORMATION WITH THEORY OF OPERATION

FPU® SYSTEMS OPERATION MANUAL (INCLUDING REPAIR PARTS & SPECIAL TOOL LIST)

BOH CONTAINERIZED MISSION SYSTEMS

CCC and EWCC

BOH FPU Field Pack-up Units

CCC THEORY OF OPERATION

Scope

This work package will explain the operation of the CCC.

Containerized Command Center (CCC) Features

CCC TRANSPORT

- CCC is a self-contained 4-man work station.
- All-steel container measures 8' W x 8' H x 20' L, designed for use as an expeditionary command, logistics support, or disaster response facility.
- The CCC is a rugged unit with coved walls and sweep-out thresholds for ease of cleaning during inclement weather and is capable of full intermodal transportation moves as secondary load on CT/MT ship. A power distribution box (110v 60 Hz) is also included.
- Other features include 2 end doors; electrical raceway w/ outlets; retractable HVAC; switchable white/red lighting; 4 desk/computer work stations each w/ phone connection; 5 lockable file cabinets; grounding lug w/ cable and spike; and FRP interior walls and ceiling.
- **The CCC is not an ISO-certified or CSC Safety-Approved container.** Eight ISO corner blocks (one at each corner) are provided for lifting the CCC with a Rough Terrain Container Handler (RTCH) and for ground transport platforms (PLS, HEMTT, PLS Flatrack, PLS Chassis).
- The CCC has four fork pockets, two on each side, for forklift transport and movement.
- Container tare weight is 8,770 lbs.

CCC UPGRADES

- The CCC is provided 2 entrance doors at both ends of the container with deadbolts, lock sets and stainless hinges.
- The CCC offers a variety of storage cabinets and desks, with a seamless desk top.
- The CCC has a shelf system that provides a base with securing straps for equipment and documents, located above each work station.
- The CCC includes a 6-ft grounding rod and fire extinguisher securing bracket.

CCC HVAC AND ELECTRICAL SERVICE

- The previous 24000 BTU Friedrich HVAC has been discontinued and replaced with an equivalent LG HVAC. See page 0009 00-6.
- The HVAC unit is retractable when the CCC is to be stored or transported.
- The CCC is provided with external compartments for protection of power/communications connections on the center rear side, see page 0009 00-1.
- The CCC is provided three ceiling-mounted red/white 120 VAC fluorescent light fixtures.
- To the right of the main entrance door there are two switches: a red/white light selector switch and a selector switch with options for the door activated interrupter, off, and continuous lighting.
- There are banks of three-prong electrical outlets for 110 VAC service along the left and right wall above the work stations and desks.
- The CCC circuit breaker panel is located on the center of the interior back wall just next to communication connections and grounding rod assembly, see page 0009 00-2.

END OF WORK PACKAGE

This page was intentionally left blank

INTRODUCTORY INFORMATION WITH THEORY OF OPERATION

FPU® SYSTEMS OPERATION MANUAL (INCLUDING REPAIR PARTS & SPECIAL TOOL LIST) BOH CONTAINERIZED MISSION SYSTEMS

CCC and EWCC BOH FPU Field Pack-up Units

EWCC THEORY OF OPERATION

Scope

This work package will explain the operation of the EWCC.

Expandable Wall Command Center (EWCC) Features

EWCC TRANSPORT

- EWCC is a 6-man work station with three 2-position slide outs that expand interior work space when deployed in the "open" position.
- All-steel container measures 8' W x 8' H x 20' L. Designed for use as a self-contained expeditionary command, logistics support, or disaster response facility.
- EWCC is a rugged unit with coved walls and sweep-out thresholds for ease of cleaning during inclement weather and is capable of full intermodal transportation moves as secondary load on CT/MT ship.
- Power distribution box (110v 60 Hz). Features include 2 end doors and one single fixed observation window w/ protective shutter; electrical raceway w/ outlets; retractable HVAC; switchable white/red lighting; 6 desk/computer work stations each w/ phone connection; 5 lockable file cabinets; grounding lug w/ cable and spike; and FRP interior walls and ceiling.
- **The EWCC is not an ISO-certified or CSC Safety-Approved container.** Eight ISO corner blocks (one at each corner) are provided for lifting the EWCC with a Rough Terrain Container Handler (RTCH) and for ground transport platforms (PLS, HEMTT, PLS Flatrack, PLS Chassis).
- Container tare weight is 11,880 lbs.

EWCC UPGRADES

- The EWCC is provided entrance doors at each ends of the container with deadbolts, lock sets and stainless hinges.
- The EWCC offers a variety of storage cabinets, desks with drawers, and seamless desk tops.
- The EWCC has a shelf system that provides a base with securing straps for equipment and documents, located above each work station.
- There D-rings to assist in ratchet strap deployment of EXPANDO workstation units.
- The EWCC includes a 6-ft grounding rod and fire extinguisher securing bracket.

EWCC HVAC AND ELECTRICAL SERVICE

- The previous 24000 BTU Friedrich HVAC has been discontinued and replaced with an equivalent LG HVAC. See page 0011 00-6.
- The HVAC unit is retractable depending on whether the EWCC is to be stored or transported.
- The EWCC is provided with external compartments for protection of power/communications connections on the center rear side. The EWCC is provided three ceiling-mounted red/white 120 VAC fluorescent lights.
- To the right of the main entrance door there are two switches: a red/white light selector and a selector switch for the door activated interrupter, off, and continuous lighting.
- There are banks of three-prong electrical outlets for 110 VAC service along the left and right wall above the work stations and desks.
- The EWCC circuit breaker panel is located on the center of the interior back wall just next to communication connections and grounding rod assembly, see pages 0011 00-2.

END OF WORK PACKAGE

This page was intentionally left blank

INTRODUCTORY INFORMATION WITH THEORY OF OPERATION

**FPU® SYSTEMS OPERATION MANUAL
(INCLUDING REPAIR PARTS & SPECIAL TOOL LIST)
BOH CONTAINERIZED MISSION SYSTEMS
CCC and EWCC
BOH FPU Field Pack-up Units**

CONTAINERIZED MISSION SYSTEM ORIENTATION

CCC Orientation

For proper operation of the CCC, selecting a site to place the CCC that is a reasonably level and smooth surface is essential.

The HVAC unit is located in what is considered the front of the container, and the shore power and communications hookups are located in the rear of the container.

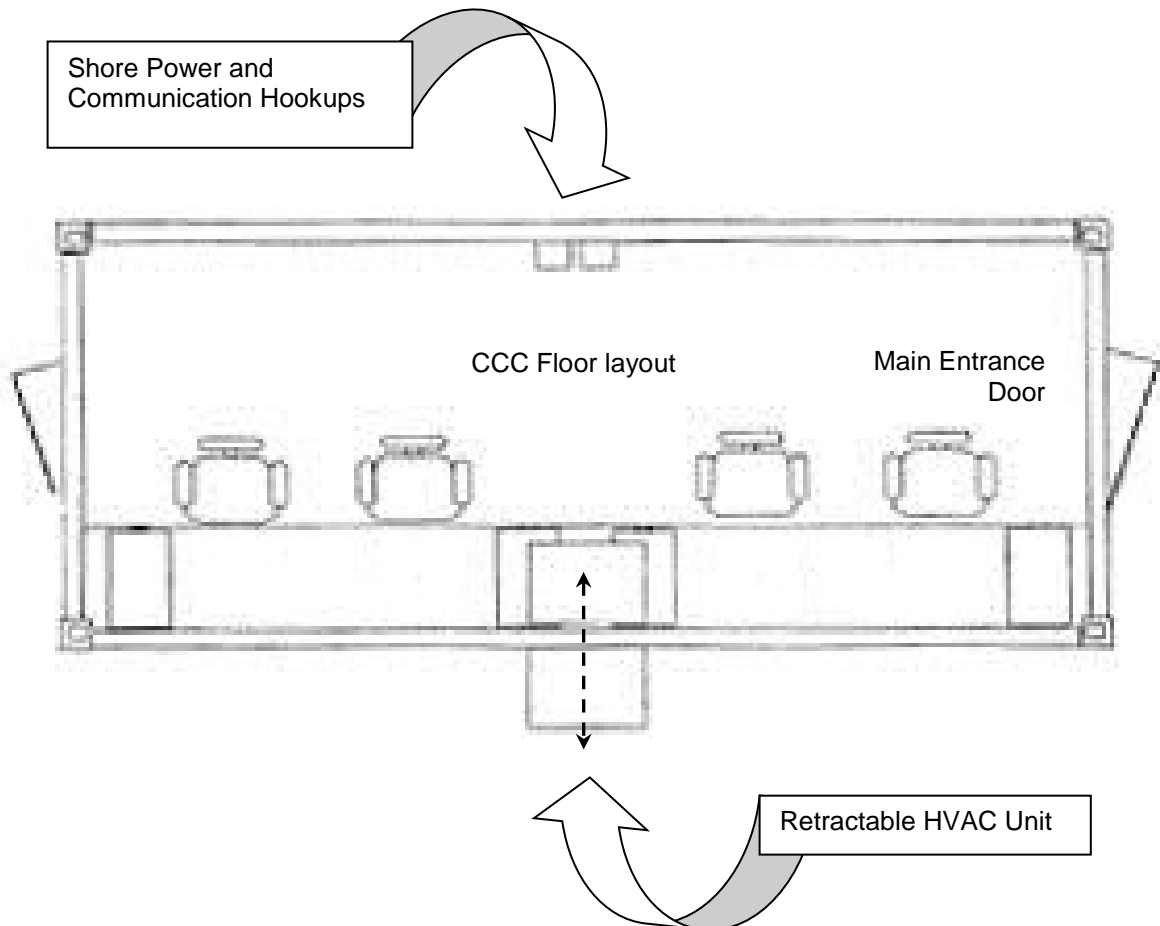
**Note**

Light interrupter switch provided at main entrance door only.

CAUTION

Ensure the HVAC is properly serviced before deployed in extreme heat and cold conditions.

EWCC Orientation

For proper operation of the EWCC selecting a site to place the CCC that is a reasonably level and smooth surface is essential.

The EWCC Window is located in what is considered the front of the container and the shore power and communications hookups are located in the rear of the container.

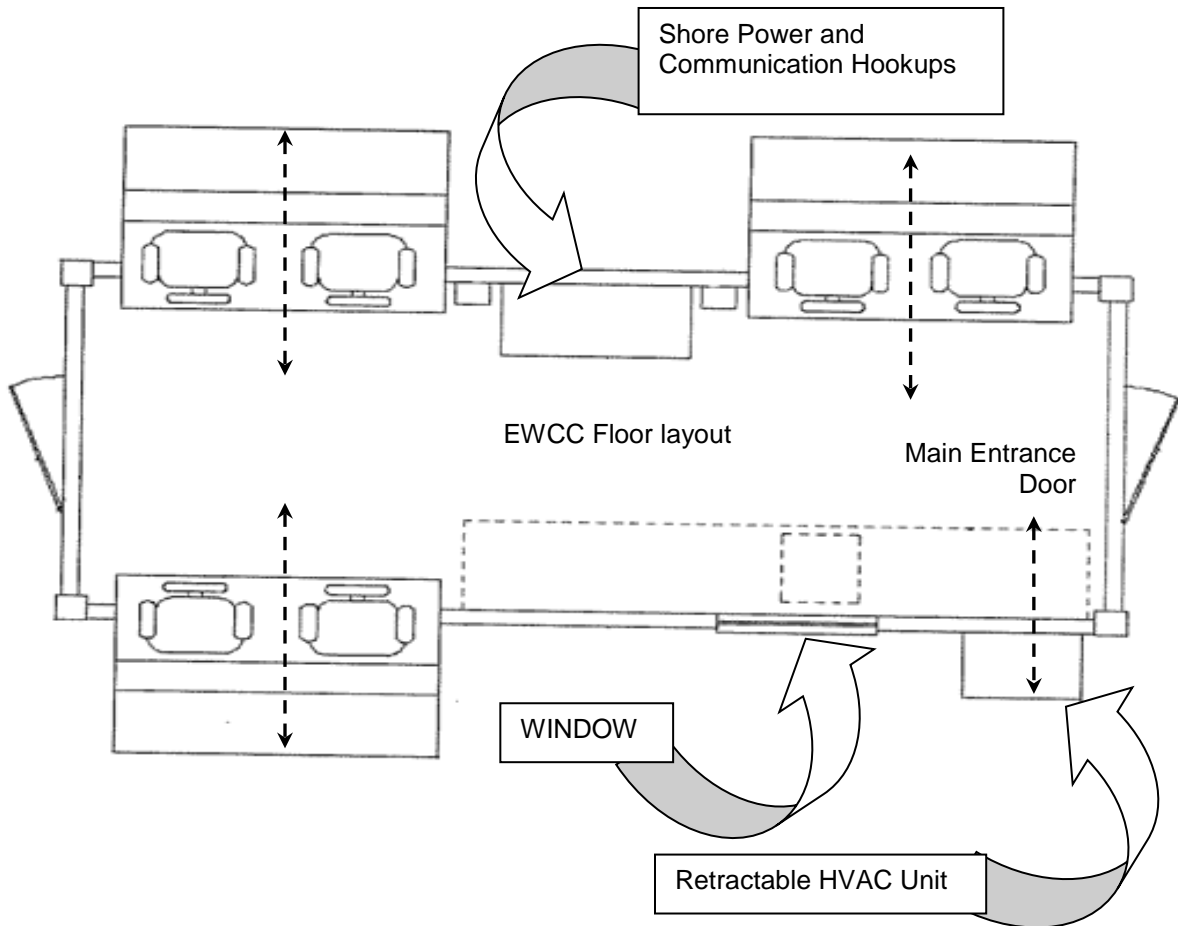

Note

Light interrupter switch provided at main entrance door only.

CAUTION

Ensure the HVAC is properly serviced before deployed in extreme heat and cold conditions.

END OF WORK PACKAGE

INTRODUCTORY INFORMATION WITH THEORY OF OPERATION**FPU® SYSTEMS OPERATION MANUAL
(INCLUDING REPAIR PARTS & SPECIAL TOOL LIST)
BOH CONTAINERIZED MISSION SYSTEMS
CCC and EWCC
BOH FPU Field Pack-up Units****MISSION SYSTEM CHARACTERISTICS, COMPONENTS AND ACCESSORIES**

New CCC and EWCC HVAC units

The 24000 BTU Friedrich HVAC model has been discontinued and replaced with a comparable LG HVAC model. Both the CCC and EWCC have retractable HVAC units.



Discontinued 24000 BTU Friedrich units beginning with Serial # ACCCC208-03144 (CCC) and ACEWCC208-03233 (EWCC).



New 24000 BTU LG units beginning with Serial # ACCCC208-03177 (CCC) and ACEWCC208-03347 (EWCC).

CCC Lighting Systems

The latest generation of the CCC has been upgraded to three 4' long 120 VAC fluorescent light fixtures (1) beginning with CCC serial number ACCCC208-03144.

Old 12 VDC System prior to SN ACCC208-03144

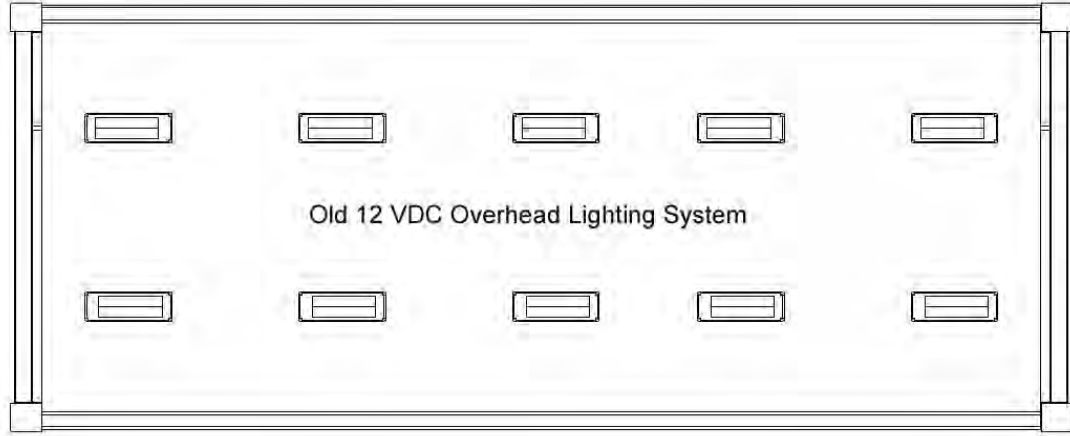

New 120 VAC System SN ACCCC208-03144 and beyond

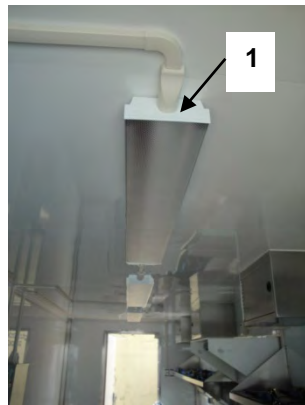
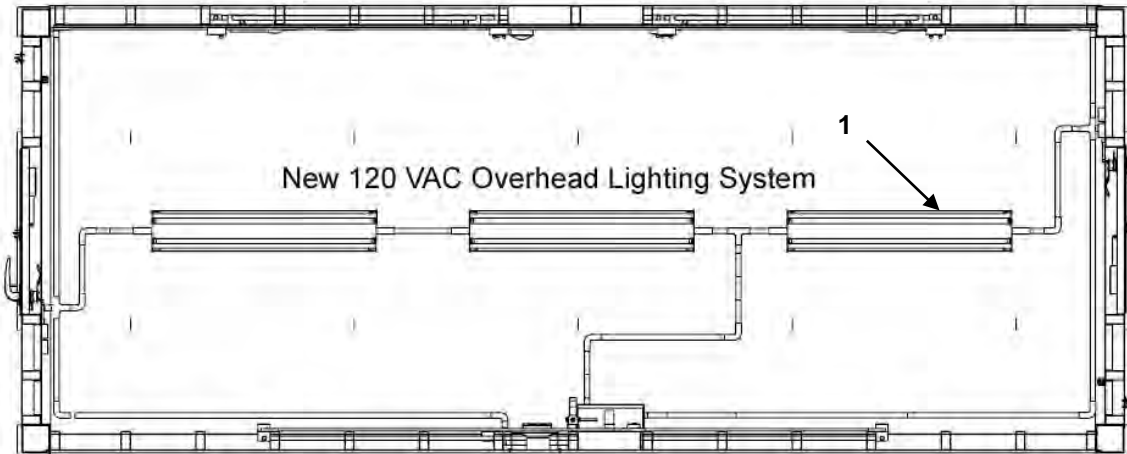

EWCC Lighting Systems

The latest generation of the EWCC has been upgraded to six 4' long 120 VAC fluorescent light fixtures (1) beginning with EWCC serial number ACEWCC208-03234.

Old 12 VDC System prior to SN ACEWCC208-03234

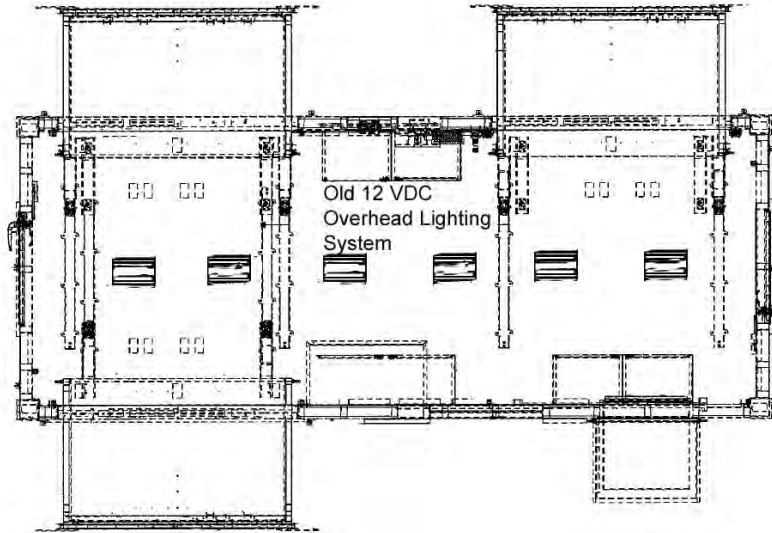

New 120 VAC System SN ACEWCC208-03234 and beyond

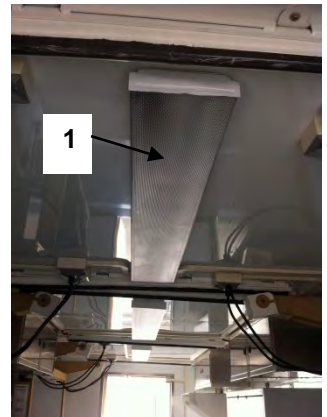
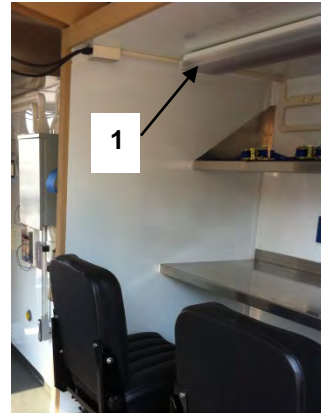
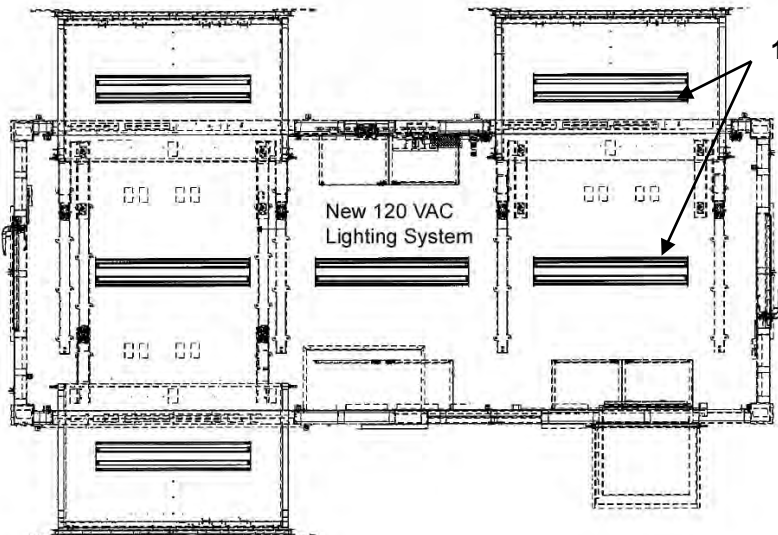

CCC Exterior Connections

The CCC is provided with dual communication connection boxes (1), a shore power connection box (2) with protective weather covers and external ground lug (3) for the ground rod.

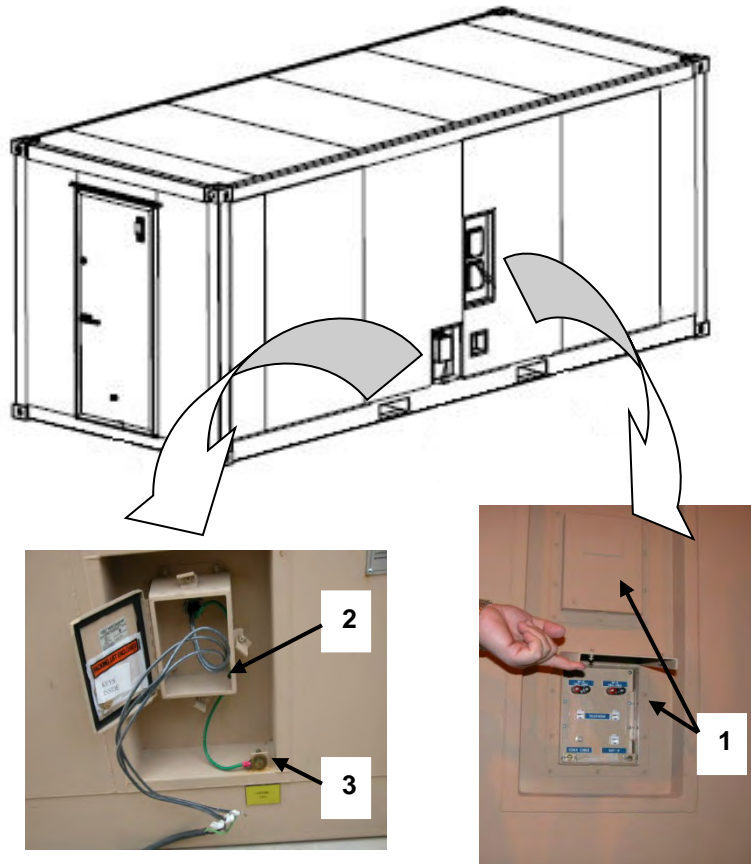

NOTE

New communication pass-through connections provided beginning with CCC serial # ACCCC208-03177. See page 0005 00-6 for details.

WARNING



The electrical ground must be established first to prevent electrical shock to personnel. Consult DOD 60055.9-STD Chapter 7 Grounding.

NOTE

3-ft grounding rod replaced with 6-ft version beginning with CCC serial # ACEWCC208-03195.

EWCC Exterior Connections

The EWCC is provided with three communication connection boxes (1), a shore power connection box (2) with protective weather covers and external ground lug (3) for the ground rod.

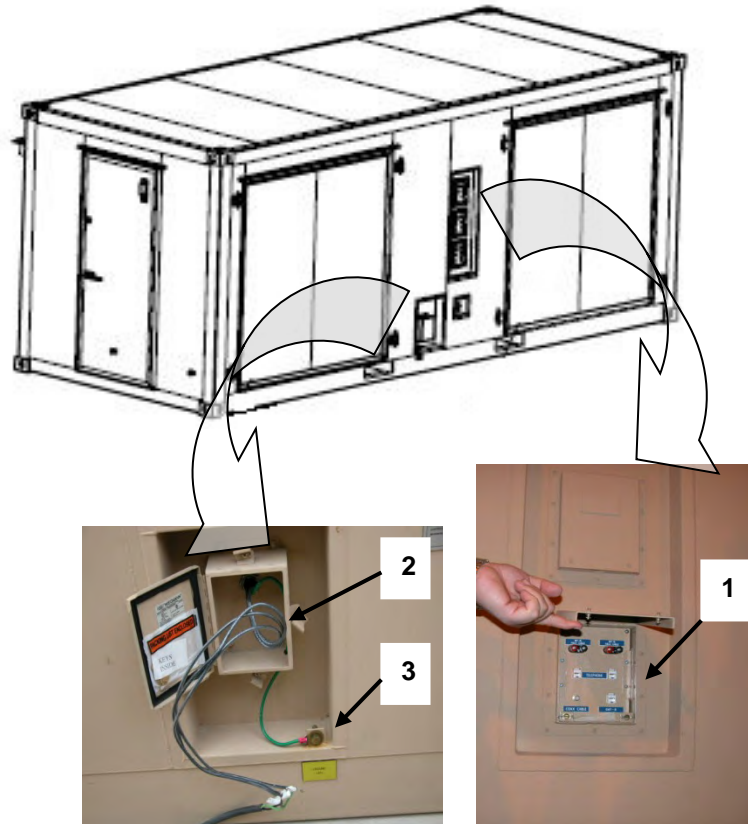

NOTE

New communication pass-through connections provided beginning with EWCC serial # ACEWCC208-03338. See page 0005 00-6 for details.

WARNING



The electrical ground must be established first to prevent electrical shock to personnel.
Consult ARMY TM 5- 811-3 Chapter 2 and MIL-HDBK 149A Chapter 2-5.

NOTE

3-ft grounding rod replaced with 6-ft version beginning with EWCC serial # ACEWCC208-03440.

New Communication Cable Pass-through Conduits (Interior View)

(Beginning with Serial # ACCCC208-03177 (CCC) and ACEWCC208-03338 (EWCC))

The new communication cable pass-through conduits are located on the side wall adjacent to the load center (1). The bottom two conduits (2) are used to pass and connect communication cables into multi-port panels (3). There is also a third conduit (4) used to pass additional cables. In addition, each of the conduits includes a vinyl boot to secure the cables with Velcro and minimize the intrusion of insects, blowing sand, etc. from entering the container when in use.

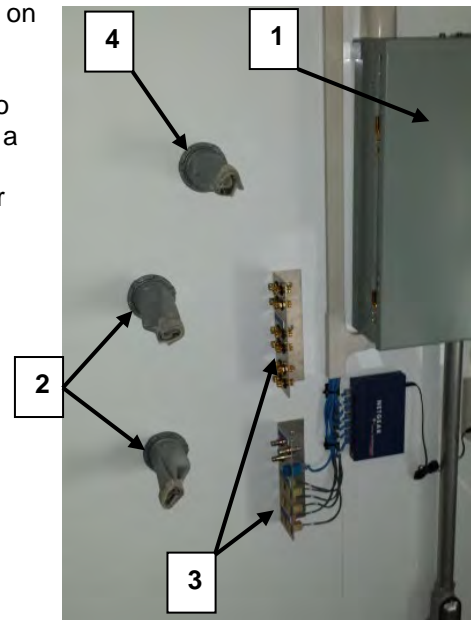

New Communication Cable Pass-through Connections (Exterior View)

The new communications cable pass-through conduits are located on the exterior side wall adjacent to the shore power box. All three conduits are provided with tethered caps (5) to prevent the intrusion of insects, blowing sand, etc. from entering the container when not in use.

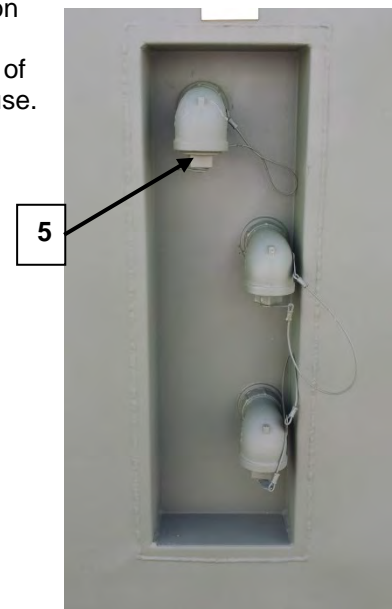

END OF WORK PACKAGE

INTRODUCTORY INFORMATION WITH THEORY OF OPERATION

FPU® SYSTEMS OPERATION MANUAL
 (INCLUDING REPAIR PARTS & SPECIAL TOOL LIST)
 BOH CONTAINERIZED MISSION SYSTEMS
 CCC and EWCC
 BOH FPU Field Pack-up Units

EQUIPMENT DATA LABELS, IDENTIFICATIONS, MARKINGS

EQUIPMENT DATA PLATE LOCATIONS

The BOH ISO data plates are affixed at the rear of each container, next to the shore power connection box. This plate identifies container type, model and serial number.

CCC Data Plate

The CCC Data plate is located just below the communication connection bank at the rear of the container.

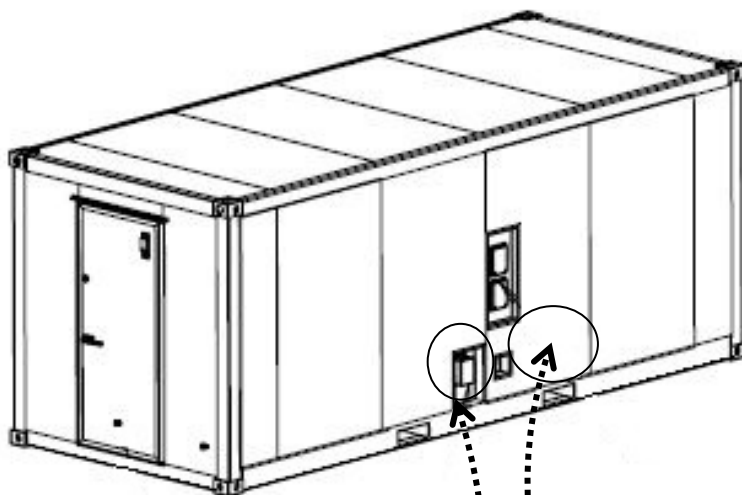

BOH CONTAINERIZED MISSION SYSTEM	
MANUFACTURER ADVANCED CONTAINMENT SYSTEMS INC. 8720 LAMBRIGHT HOUSTON, TX. 77075 TEL. (713) 987-0396 FAX. (713) 987-0366	PATENT HOLDER / PRIME CONTRACTOR BOH FPU SYSTEMS BOH ENVIRONMENTAL, LLC 143 TERRA BELLA BLVD. COVINGTON, LA 70438 TEL. (986) 874-0725
MSN	<input type="text"/>
MODEL NO.	<input type="text"/>
MANUFACTURER'S P/N	<input type="text"/>
PATENT NUMBER	<input type="text"/>
SERIAL NUMBER	<input type="text"/>
DATE MANUFACTURED	<input type="text"/>
CONTRACT NUMBER	<input type="text"/>
DO NO.	<input type="text"/>
MAXIMUM GROSS WEIGHT	<input type="text"/> KG <input type="text"/> LB
	GROUND AIR <input type="text"/> KG <input type="text"/> LB

EWCC Data Plate

The EWCC Data plate is located just below the communication connection bank at the rear of the container.

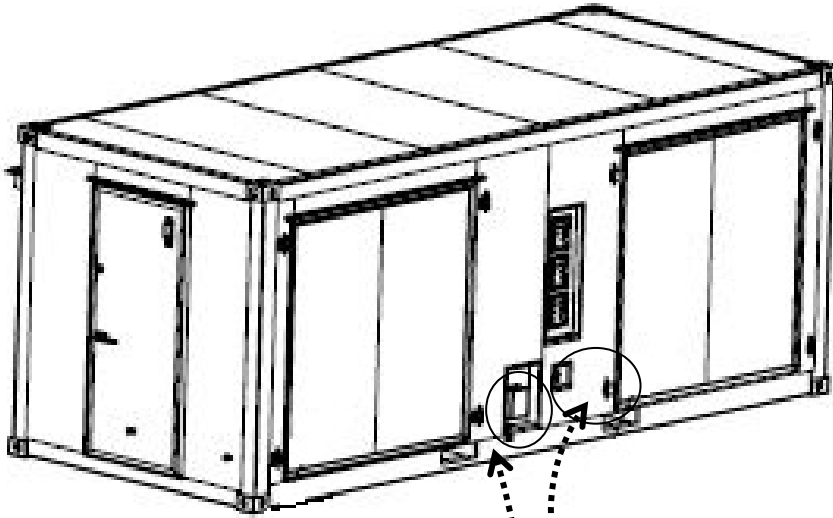

BOH CONTAINERIZED MISSION SYSTEM	
MANUFACTURER ADVANCED CONTAINMENT SYSTEMS INC. 8720 LAMBRIGHT HOUSTON, TX. 77075 TEL. (713) 987-0396 FAX. (713) 987-0366	PATENT HOLDER/ PRIME CONTRACTOR BOH FPU SYSTEMS BOH ENVIRONMENTAL, LLC 143 TERRA BELLA BLVD. COVINGTON, LA 70433 TEL. (985) 674-0726
NSN	
MODEL NO.	
MANUFACTURER'S P/N	
PATENT NUMBER	
SERIAL NUMBER	
DATE MANUFACTURED	
CONTRACT NUMBER	
DO NO.	
MAXIMUM GROSS WEIGHT	
GROUND	KG LB
AIR	KG LB

Other EWCC and CCC Identifications and Markings

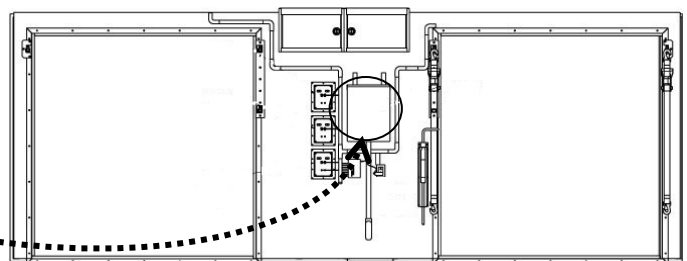
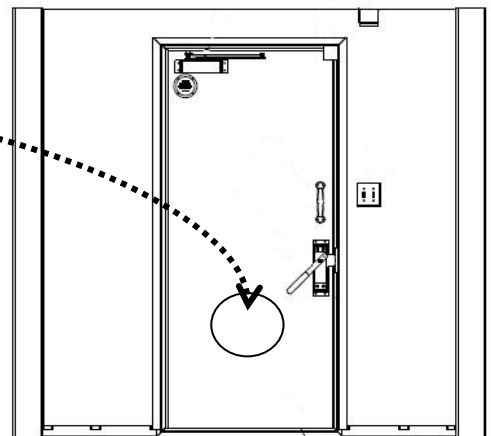
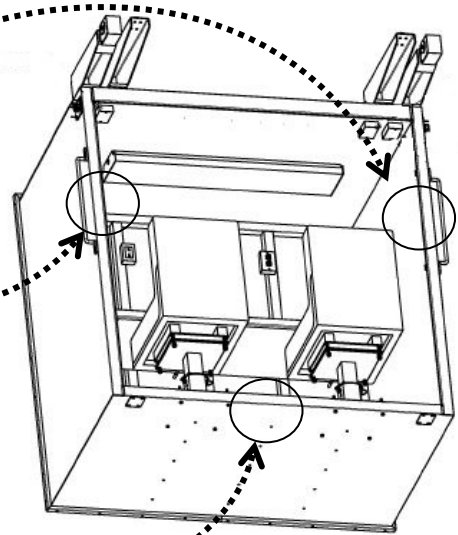

REPORTING EQUIPMENT IMPROVEMENT RECOMMENDATIONS (EIR)

If your CCC or EWCC needs improvements in design and/or performance, let us know. Send us a description of the recommended change to dcesap@bohfpusystems.com.

CORROSION PREVENTION AND CONTROL (CPC)

It is our understanding that Corrosion Prevention and Control (CPC) is a continuing concern for the military. While corrosion is typically associated with rusting of metals, it can also include deterioration of other material, such as rubber and plastic. Unusual cracking, softening, swelling, or breaking of these materials may be a corrosion problem.

All units must adhere to their specific corrosion maintenance plan. At a minimum, equipment should be inspected for corrosion on a quarterly basis (monthly if equipment is operated/stored in a high salt air environment). If corrosion is discovered, consult your unit/installation corrosion control manager to schedule repair. It is important that any corrosion problem with the FPU be reported so that the problem can be corrected and improvements can be made to prevent the problem in the future.

PREPARATION FOR STORAGE OR SHIPMENT

All preventative maintenance checks and services should be performed on the systems and their components prior to any storage or shipment. See page 0007 00-2 for steps required prior to transporting or storing the EWCC or CCC unit.

RECEIVING THE SYSTEM INVENTORY

Unpacking and Inventory of System Components upon Initial Receipt

With the System containers downloaded, check the equipment against the packing list. Report any discrepancy to your supervisor.

END OF WORK PACKAGE