

**FPU® SYSTEMS OPERATION MANUAL
BOH PORTABLE DRAWER MODULE (PDM)
(INCLUDING REPAIR PARTS & SPECIAL TOOL LIST)
BOH FPU Field Pack-up Units**

CHAPTER 4

OPERATOR MAINTENANCE INSTRUCTIONS

This page was intentionally left blank

OPERATOR MAINTENANCE INSTRUCTIONS

FPU® SYSTEMS OPERATION MANUAL BOH PORTABLE DRAWER MODULE (PDM) (INCLUDING REPAIR PARTS & SPECIAL TOOL LIST) BOH FPU Field Pack-up Units

INTRODUCTION TO PREVENTATIVE MAINTENANCE CHECKS & SERVICES (PMCS)

INITIAL SETUP:

Materiel/Parts

None

Personnel Required

One

References

None

Equipment Condition

BOH PDM MODULE Set-up

INTRODUCTION TO PREVENTATIVE MAINTENANCE CHECKS & SERVICES (PMCS)

Preventative Maintenance Checks and Services (PMCS) are performed to keep the FPU System containers in good operating condition. These checks aid in finding, correcting, or reporting problems. Operator personnel are to perform the PMCS tasks as shown in the PMCS table.

Perform PMCS procedures each day the BOH PDM MODULE is in operation, using the PMCS table in WP 0014 00. There are different intervals to perform PMCS procedures: before, during and after using the equipment, as well as weekly and monthly. Look at the table carefully to identify the required PMCS interval.

Perform all checks and services keeping in mind the following guidelines:

- Before you begin using the BOH PDM MODULE , do **Before Operation PMCS**
- While the BOH PDM MODULE is in use, do **During Operation PMCS**
- After using the BOH PDM MODULE , do **After Operation PMCS**

If you find something wrong when performing PMCS, fix it using troubleshooting and/or maintenance procedures. Pay attention to WARNING and CAUTION statements. A **WARNING** means someone could be injured or killed. A **CAUTION** means equipment could be damaged.

If tools that are required to perform PMCS are not listed in the procedures, notify your supervisor.

Inspection

Look for signs of trouble. Use your senses to feel, smell, hear, or see problems that may exist. Inspect to see if items are in good condition. Are components correctly installed and secured? Is any damage to the frame or components visible? Correct any faults or notify Unit Maintenance.

Associated Components

There are some common items to check on the FPU SYSTEM and associated equipment. These include the following:

- Condition and proper connection of ratchet straps.
- Condition and proper connection of the forklift base plate

Service

Proper service of the BOH PDM MODULE and components is an integral part of maintenance. Regular cleaning prevents possible problems in the future, so make it a habit to clean the BOH PDM MODULE and components whenever necessary.

END OF WORK PACKAGE

OPERATOR MAINTENANCE INSTRUCTIONS

FPU® SYSTEMS OPERATION MANUAL BOH PORTABLE DRAWER MODULE (PDM) (INCLUDING REPAIR PARTS & SPECIAL TOOL LIST) BOH FPU Field Pack-up Units

PMCS TABLE

INITIAL SETUP:
Materiel/Parts

Rags, Water

Personnel Required

One to four

References

None

Equipment Condition

BOH PDM MODULE Set-up

**Table 1 Preventative Maintenance Checks and Services for the BOH PDM MODULE
PMCS B (Before), D (During), A (After), W (Weekly), M (Monthly)**

	B	D	A	W	M	Inspection Item and Procedure	Equipment Not Ready/Available If
1	*		*	*		RACHET STRAPS Check for missing ratchet straps. Each module should have two ratchet straps. Check ratchet straps for tears, frays or discoloration. This will indicate failure of the strap. Check ratchet strap hook and ratchet for proper operation. Replace as needed.	WARNING Ratchet straps that are damaged or missing could cause injury or damage to the equipment. See WP 0006
2	*		*			MODULE TRAYS AND CASES Check all frames for cracks, dents, holes, or loose/missing hardware. Check frame latches for freedom of operation. Check spring for distortion. Check for accumulations of dirt, debris, ice, snow, or salt. Clean as required. Lubricate with WD-40 lubricant spray. Replace missing or damaged hardware.	Weld crack damage will cause malfunction and hazard or injury.
3					*	Lubricate hinges, latches, with WD-40 lubricant spray as required.	Hinges and latches do not operate smoothly.
4	*		*	*		DRAWER Exterior Check all exterior surfaces for cracks, dents that effect the operation of the module system. Check drawer hinge weld for cracks or distortion. Check drawer latches for freedom of operation. Check for loose rivets. Check for accumulations of dirt, debris, ice, snow, or salt. Clean as required.	Damage that would cause malfunction of the module system or cause hazard or injury.

	B	D	A	W	M	Inspection Item and Procedure	Equipment Not Ready/Available If
5	*	*	*	*		DRAWER Interior Check drawer for dirt and debris. Clean with a brush or rags as required. Check cutout drawer dividers at the struts for proper position. Check all drawer dividers for dents, bends or distortion. Check for missing, bent or distorted center dividers. Replace dividers if needed. Check gas spring cylinders for freedom of operation, bent or damaged shaft or missing cylinder head retention clips. Replace as necessary.	Failure to position the cutout dividers will impede the operation of the drawer and/or damage the lid or gas spring cylinder. Damaged strut cylinders will render the lid inoperable. See chapter 2 WP 0008 00-2
6	*		*		*	Drawer Seal Check drawer seals for cuts, cracks, distortion, proper alignment and attachment. Reattach with proper glue or replace if necessary. Check for moisture on or in material.	Failure of the seal will allow water and moisture to enter the drawer and damage the stored material in the drawer.
7	*		*		*	Attachment Rivets Check for missing or loose attachment rivets on drawer handles, drawer latches, side, front and rear drawer dividers and all frame bearing guide pads. Schedule shop replacement if necessary.	Loose or missing rivets will impede the operation and may cause injury or damage.
8	*		*		*	Forklift Base Plate Check for weld cracks, bends, dents or frame distortion. Check tie-down rings for weld cracks, breaks or distortion. Replace or schedule weld shop repair if needed.	Failure to repair welds or tie-down rings will cause damage or injury.
9			*		*	Data Plates Check plates for legibility, damage and/or missing. Clean with water and rag. Replace as needed.	N/A
End Of PMCS Table							

END OF WORK PACKAGE

OPERATOR MAINTENANCE INSTRUCTIONS

FPU® SYSTEMS OPERATION MANUAL BOH PORTABLE DRAWER MODULE (PDM) (INCLUDING REPAIR PARTS & SPECIAL TOOL LIST) BOH FPU Field Pack-up Units

CLEANING AND LUBRICATING

INITIAL SETUP:
Materiel/Parts

Rags, Water, Detergent

Personnel Required

One

References

None

Equipment Condition

BOH PDM MODULE Set-up

CLEANING AND LUBRICATING

Cleaning and Lubricating of the BOH PDM MODULES is performed to keep the module and its associated equipment in good operating condition. The cleaning and lubrication of the module can be conducted along with the Preventative Maintenance Checks and Services (PMCS) procedures described in WP 0014 00. Specific areas described below need to be cleaned after an operational event or periodically if stored/staged outside of a fixed facility to keep the modules, and accessories performing as designed. Cleaning also assists in maintaining the condition of the materiel stored within the system. Any damage discovered when cleaning and/or lubricating that cannot be corrected using the troubleshooting procedures described in WP 0012 00 should be reported for corrective maintenance.

Table 1 Cleaning

SURFACE	OIL/GREASE	SALT/MUD/DIRT DEBRIS	RUST/CORROSION and LUBRICATION
Exterior and Interior surfaces (All)	Detergent, Water, Rags	Soapy Water, Brush, Rags	Corrosion Removal Compound and Wire Brush, Dry Rag and Spot Paint
Seals and Gaskets	Damp and Dry Rags	Damp and Dry Rags	N/A
Module Trays and Cases, Drawer handles, latches	Detergent, Water, Rags	Soapy Water, Brush, Rags	Corrosion Removal Compound and Wire Brush, Dry Rags, Spot Paint
Module Frames and Forklift Base Plate	Detergent, Water, Rags	Brush, Soapy Water, Brush, Rags	Corrosion Removal Compound and Wire Brush, Dry Rags, Spot Paint
Guide Pads	Detergent, Water, Rags	Damp and Dry Rags	WD-40 lubricant spray as needed
Drawer Hinges, Drawer Lid Strut Cylinders Shaft	Detergent, Water, Rags	Damp and Dry Rags	Corrosion Removal Compound, Dry Rags, Coat with WD-40 lubricant
Drawer Lid Strut Cylinder Body and End Connectors	Detergent, Water, Rags	Damp and Dry Rags	Corrosion Removal Compound and Wire Brush, Dry Rags
Ratchet Straps	Detergent, Water, Rags	Damp and Dry Rags	N/A

End of Cleaning Table 1

Table 2 Lubrication

USAGE	FLUID or LUBRICANT	CAPACITIES	EXPECTED TEMPERATURES	INTERVAL
Drawer Hinges	General Purpose Lubricating Oil 10W	As Required	All Temperatures	Monthly or as required if under adverse conditions
Drawer Slam Latches	Molykote Multipurpose Synthetic Grease P/N 26040124	As Required	All Temperatures	Monthly or as required if under adverse conditions
Drawer Lid Seals	N/A	As Required	All Temperatures	Monthly or as required if under adverse conditions
Door Lock Shaft Pivot Bearing	Molykote Multipurpose Synthetic Grease P/N 26040124	As Required	All Temperatures	Monthly or as required if under adverse conditions
Ratchet Straps	N/A	As Required	All Temperatures	Monthly or as required if under adverse conditions
End of Lubrication Table 2				

END OF WORK PACKAGE

OPERATOR MAINTENANCE INSTRUCTIONS

FPU® SYSTEMS OPERATION MANUAL BOH PORTABLE DRAWER MODULE (PDM) (INCLUDING REPAIR PARTS & SPECIAL TOOL LIST) BOH FPU Field Pack-up Units

INSPECTION OF RATCHET STRAPS

INITIAL SETUP:

Materiel/Parts

None

Personnel Required

One

References

Chapter 2 WP 0006 00-4 to 00-6

Equipment Condition

BOH PDM MODULES Set-up

INSPECT RATCHET STRAPS

1. Check for missing ratchet straps (1). Check straps (2) for cuts, wear, frays and discoloration.
2. Check for proper tension of straps and hooks (3) for proper connection to the forklift base plate.
3. Check hook latch (4) for distortion or damage

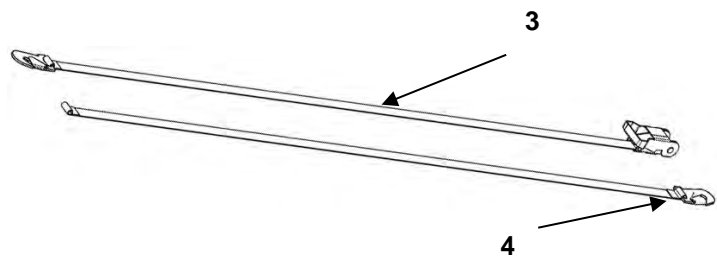
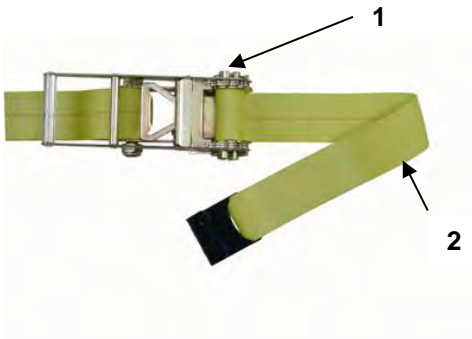

WARNING

Ratchet Straps (2) that have cuts, frays, signs of wear and discoloration indicate weakness, and the entire ratchet strap should be replaced immediately. Failure to replace could cause injury to personnel. Ratchet straps should be secure and tensioned for smooth, stable, safe operation of the module.

END OF WORK PACKAGE

This page was intentionally left blank

OPERATOR MAINTENANCE INSTRUCTIONS**FPU® SYSTEMS OPERATION MANUAL
BOH PORTABLE DRAWER MODULE (PDM)
(INCLUDING REPAIR PARTS & SPECIAL TOOL LIST)
BOH FPU Field Pack-up Units****INSPECTION OF LATCHES AND HANDLES****INITIAL SETUP:****Materiel/Parts**

None

Personnel Required

One

References

WP 0006 00

Equipment Condition

BOH PDM MODULES Set-up

INSPECT LATCHES AND HANDLES

1. Check for missing or damaged ratchet straps, front and rear (1)
2. Check drawer release operation (2).
3. Check for missing or damaged drawer handles and case handles (3).
4. Check the slam latch for damage and operation (4).

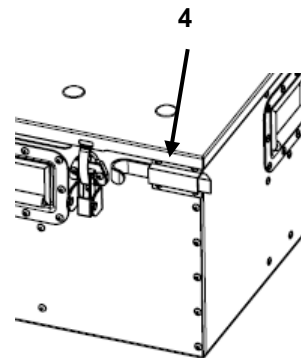
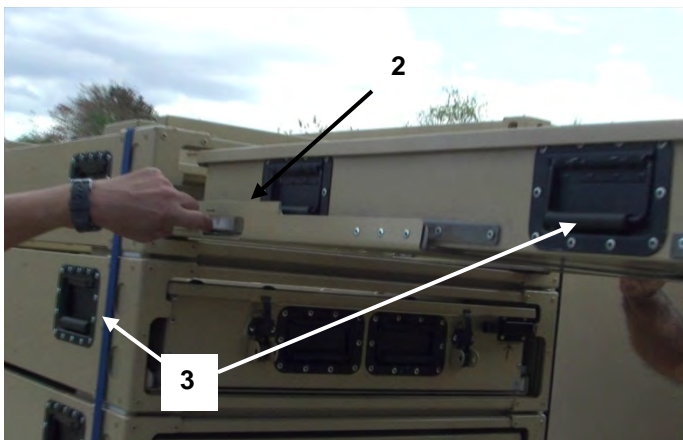
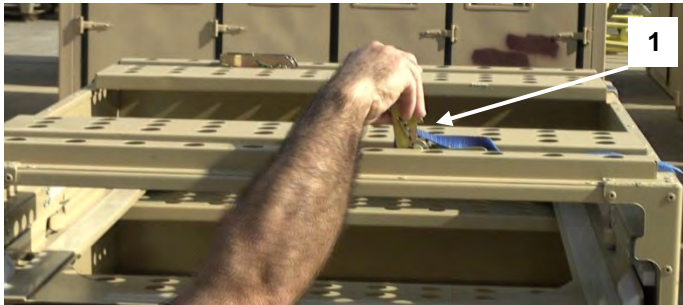

5. Release and pull out the drawer by the handles to the full extended position.
6. Check drawer tray release (1).
7. Remove the drawer (2).
8. Check for missing or damaged guide strips (3).
9. Check for external damage, dents or holes to the drawer (2).

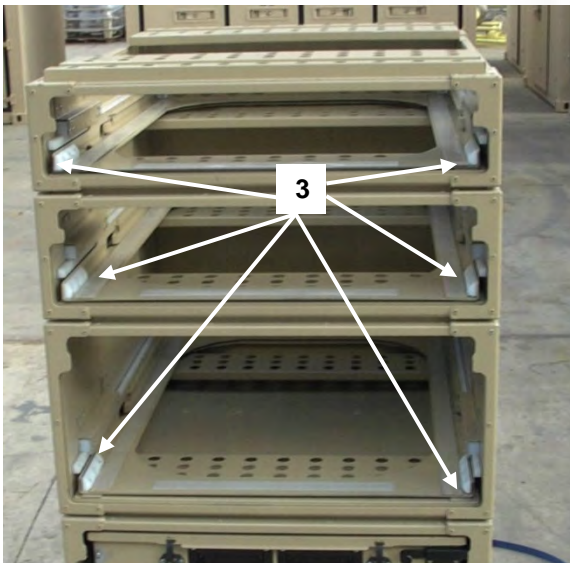
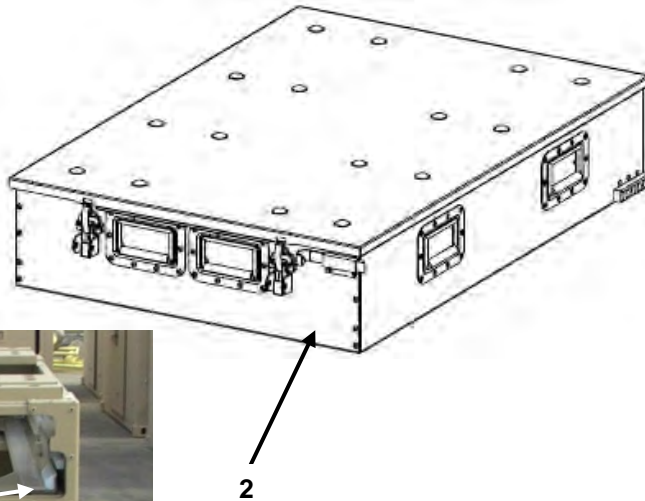
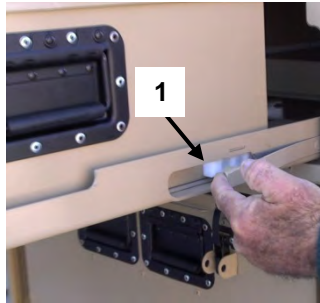

WARNING

Missing or damaged latches will cause injury to personnel during operation or movement of the module. Notify maintenance of any missing parts, damage or problems with operation of latches or handles. Repair or replace missing or damaged latches or handles immediately.

END OF WORK PACKAGE

OPERATOR MAINTENANCE INSTRUCTIONS**FPU® SYSTEMS OPERATION MANUAL
BOH PORTABLE DRAWER MODULE (PDM)
(INCLUDING REPAIR PARTS & SPECIAL TOOL LIST)
BOH FPU Field Pack-up Units****INSPECTION OF DRAWERS, CYLINDERS, SEALS AND DIVIDERS****INITIAL SETUP:****Materiel/Parts**

None

Personnel Required

One

References

Chapter 2 WP 0008 00-2

Equipment Condition

BOH PDM MODULES Set-up

INSPECT**INSPECT DRAWER ASSEMBLY**

1. With the drawer pulled to the full extended position, unlatch the drawer and raise the lid (1) to the full open position.
2. Check for missing or damaged drawer lid latches (2).

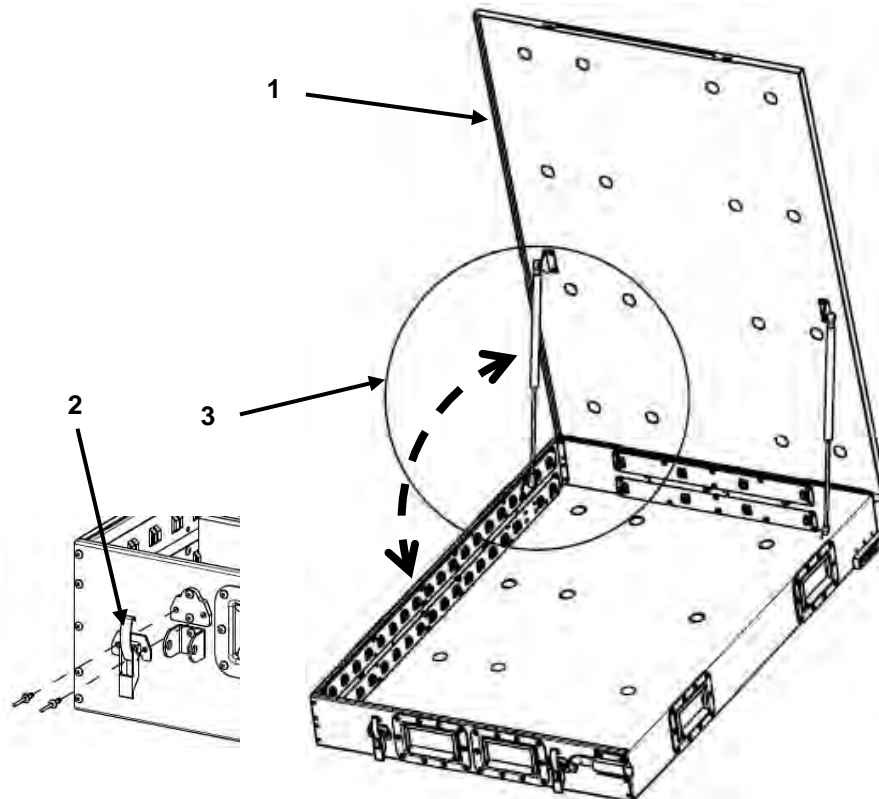

3. Check for missing or damaged strut cylinders (3).

INSPECT**DRAWER STRUT CYLINDERS**

1. Check for missing or damaged cylinder head retainer clips (1) and mounting brackets (2) at each end of the two cylinders.

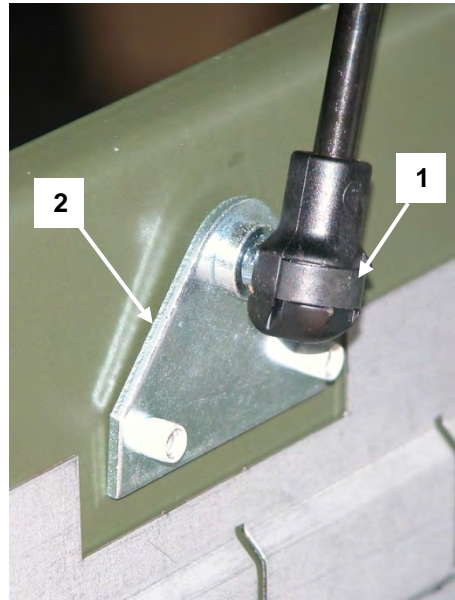
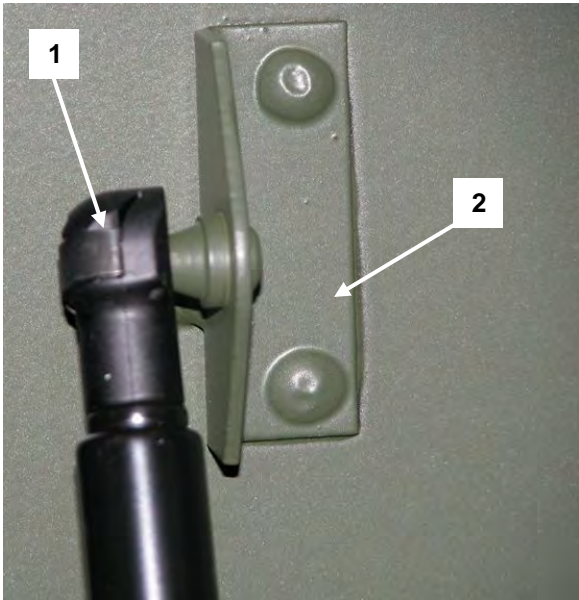
**WARNING**

Missing or damaged retainer clips (1) or mounting brackets (2) will cause injury to personnel during operation of the drawer lid. Notify maintenance of any missing or damaged lids or problems with operation of lid or cylinders. Repair or replace missing or damaged retainers or cylinders immediately.

INSPECT**DRAWER LID SEALS**

1. Check for missing or damaged continuous lid seals (1).
2. Check for cracks, distortion, and complete attachment.

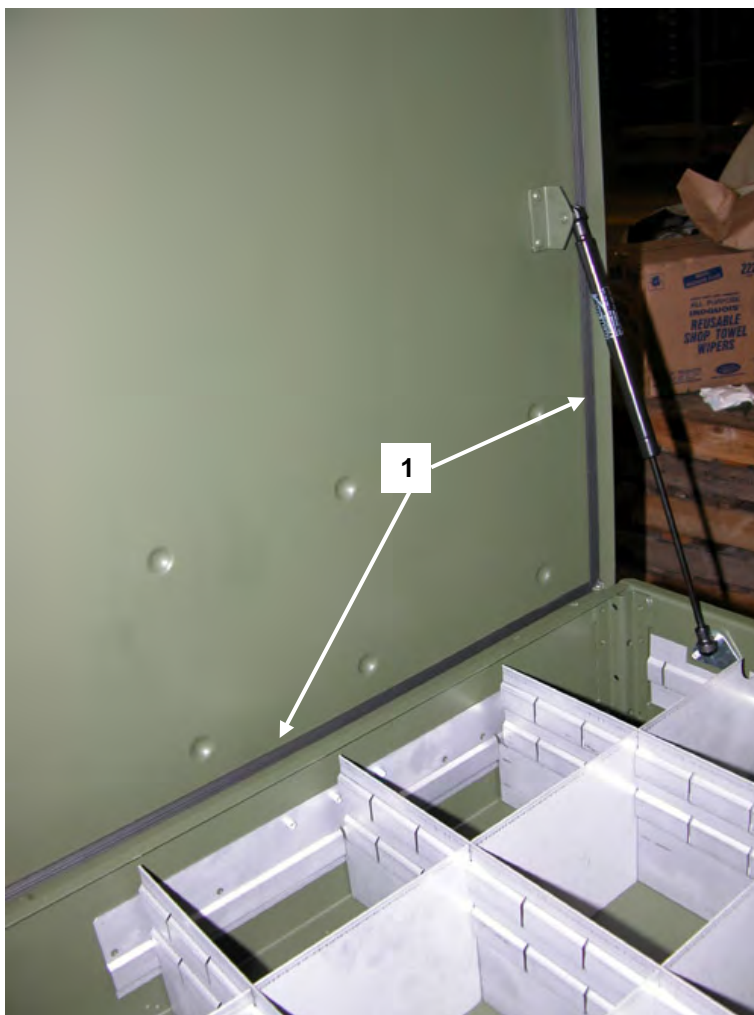
**CAUTION**

Damaged, deteriorated, or missing seals will diminish the effectiveness of the water tightness of the drawer.

INSPECT**DRAWER DIVIDERS**

1. Check for missing or damaged drawer dividers (1).
2. Check for dirt, debris, or parts under the dividers (1).
3. Check location of left and right cutout dividers (2) for their position within the first eight slots of the side divider supports.

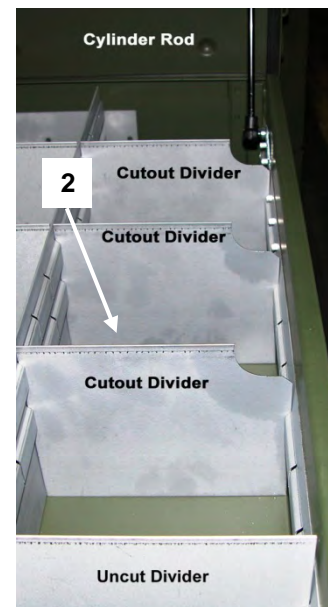
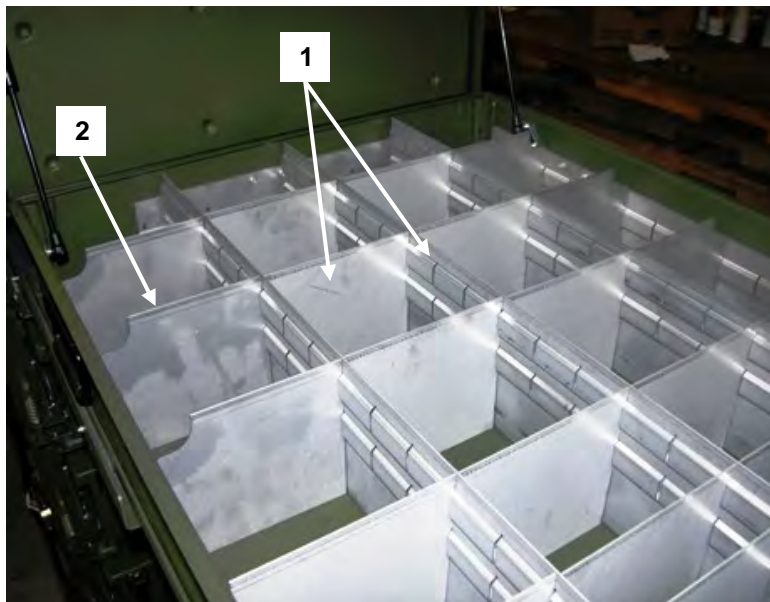
**END OF WORK PACKAGE**